

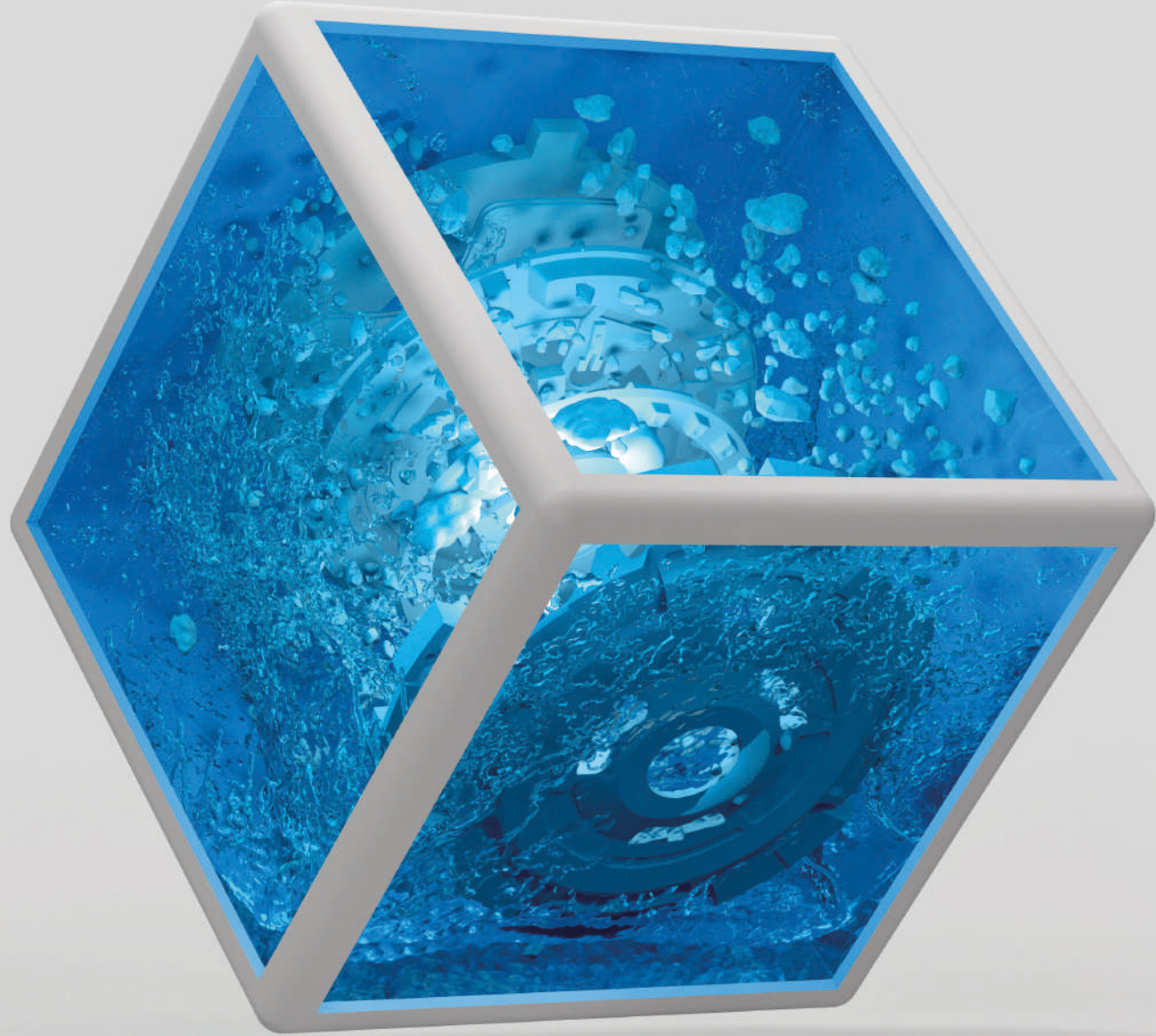

design manual



painting the future
of advanced technology



1

LOGOTYPE

1.1. Primary logo



Positive



Negative



Grayscale

Single color



1.2. Logo alternatives



Primary shape of the logo



Primary logo with tagline
when full name of company is needed



In some rare and special cases, vertical
version of the logotype is permitted.
Avoid vertical version as far as the
aesthetical/composition logic doesn't
force You.



Vertical variant with tagline
for rare cases when previous
conditions are met

1.3. Grid & Safe Zones

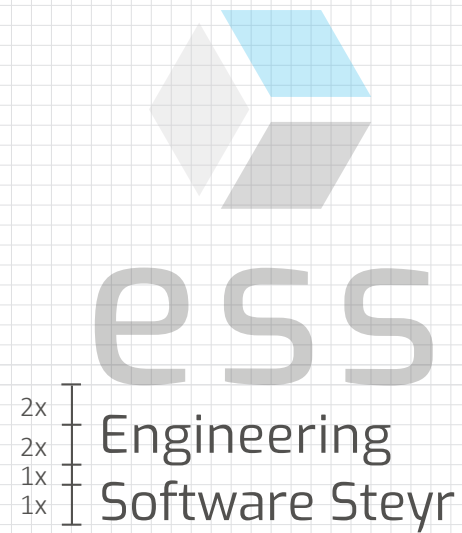
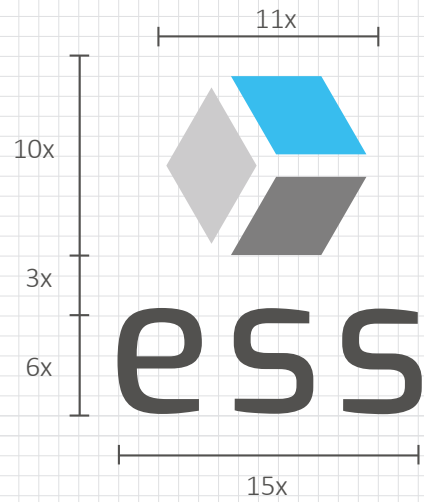
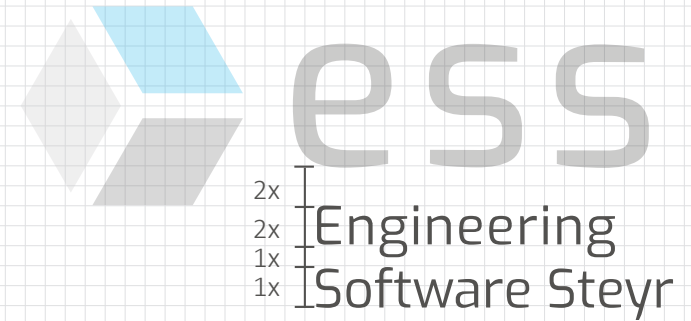
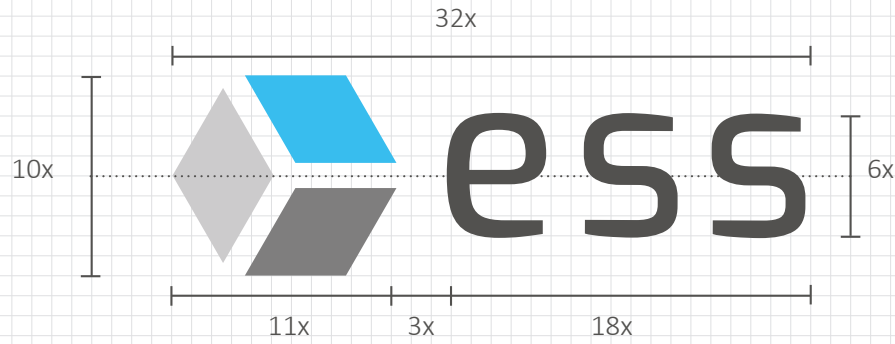

1.3. Grid & Safe Zones

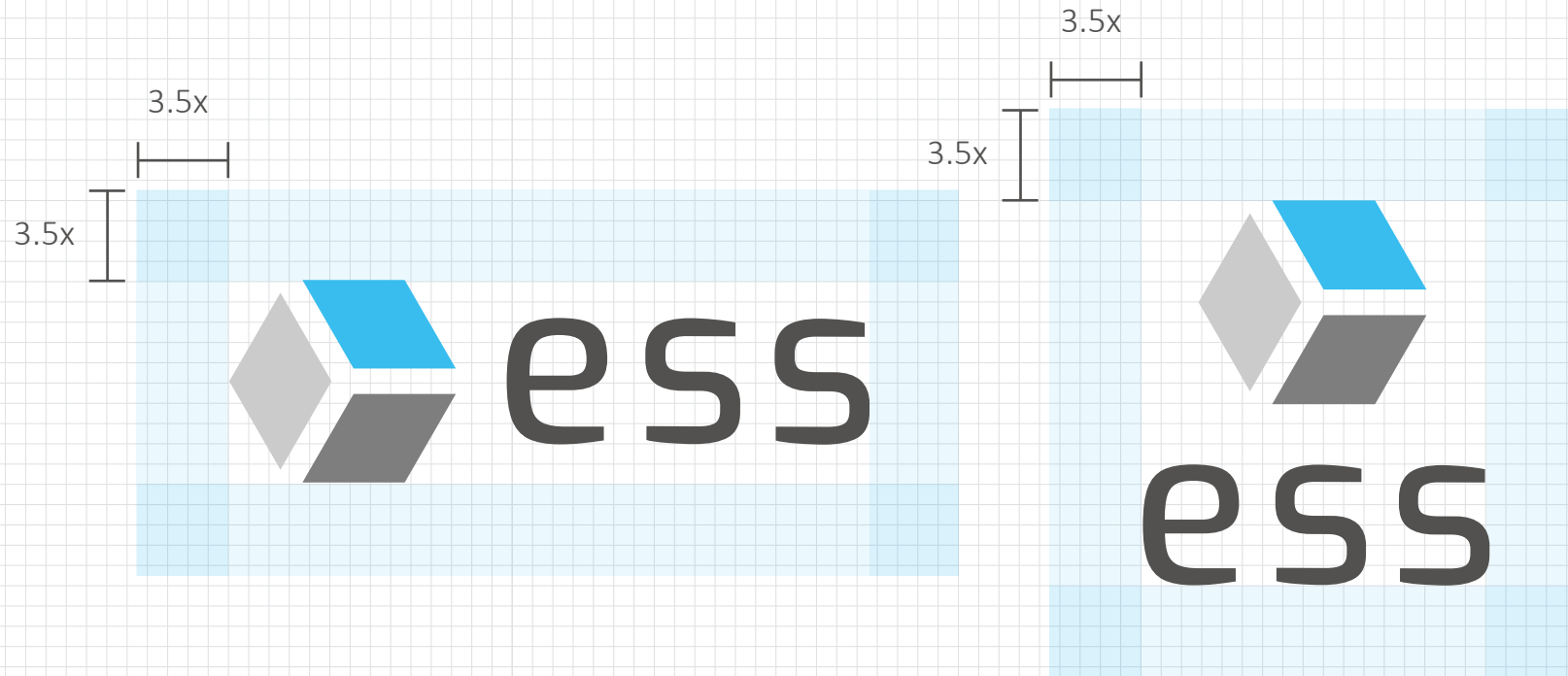

1.3. Grid & Safe Zones

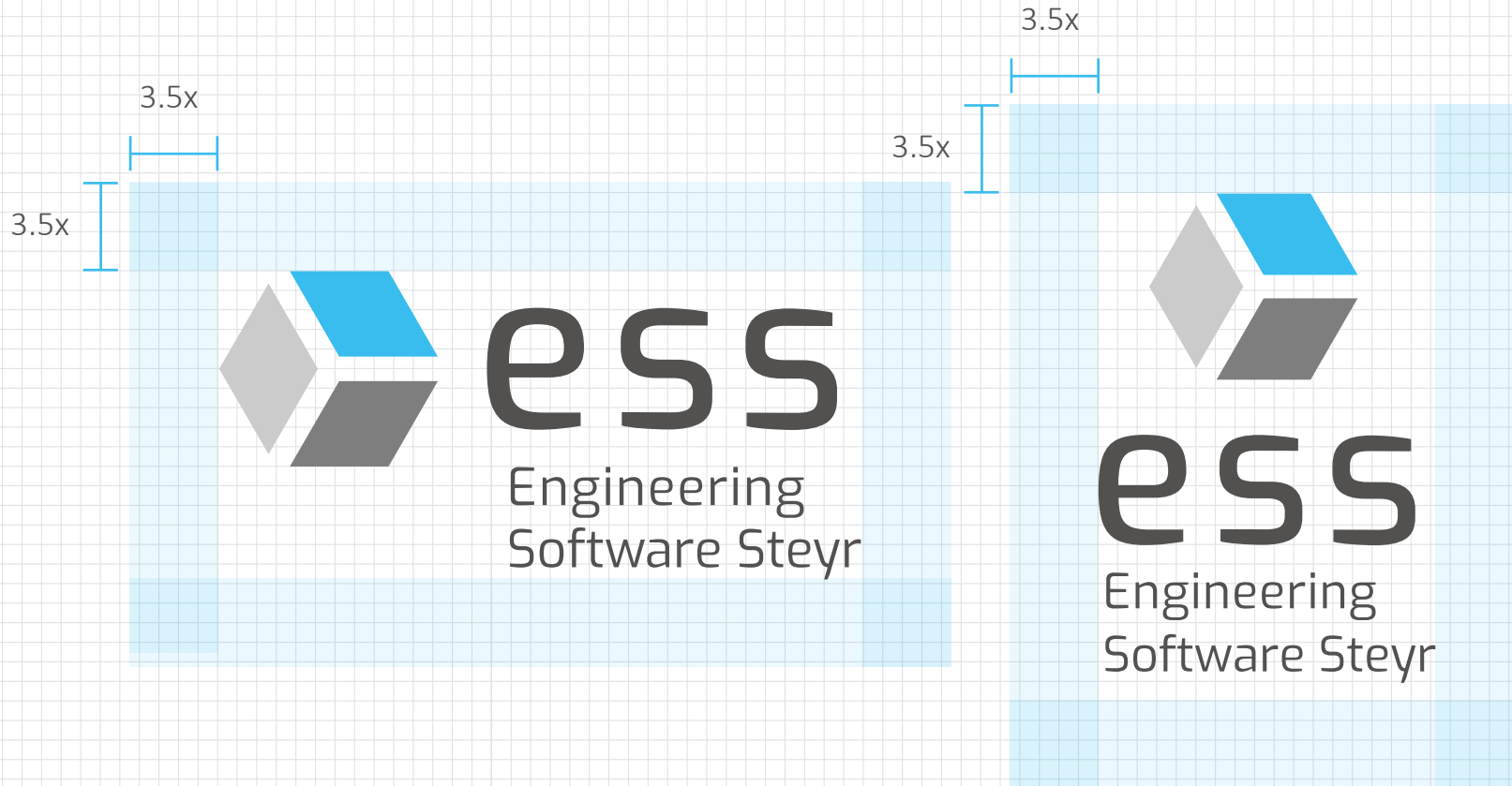

Safe zones are set as a height of blue cube side which is 3.5 x construction piece

2

ALSIM PLATFORM

1



2



3



4





Positive

Negative

Tempered

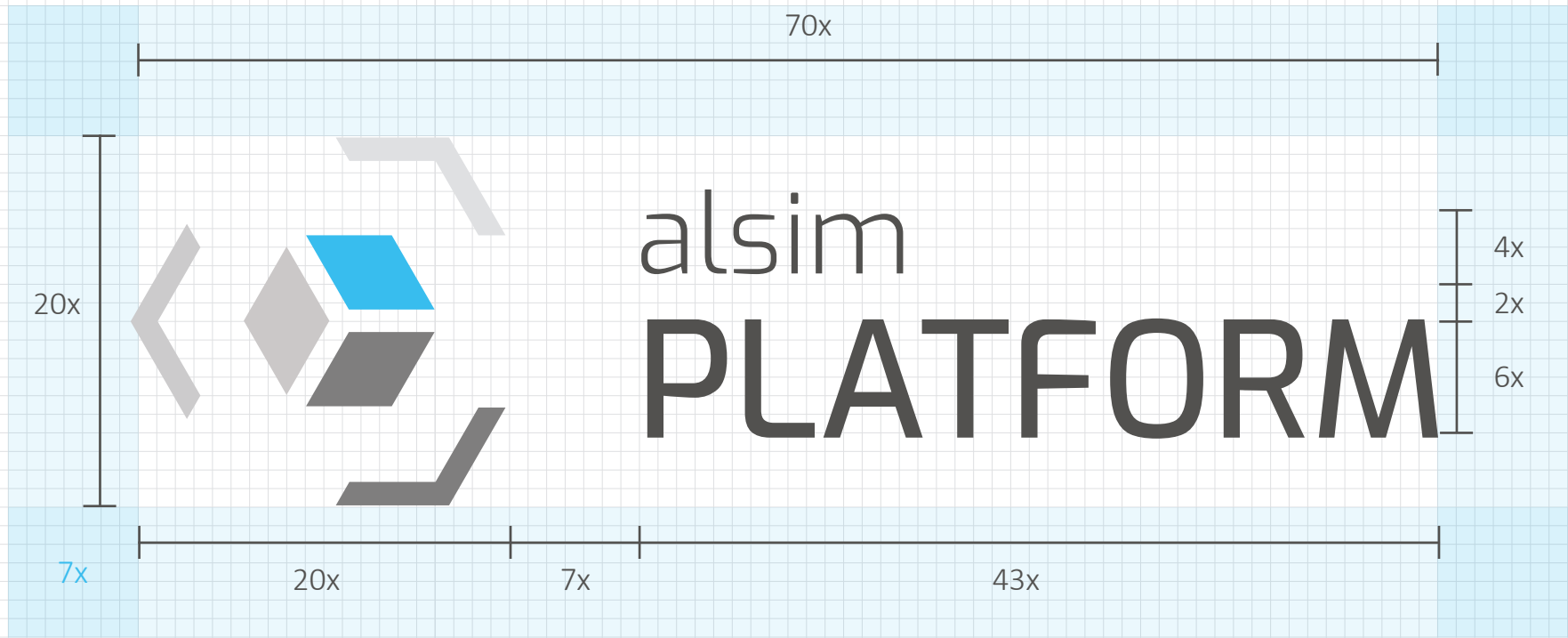

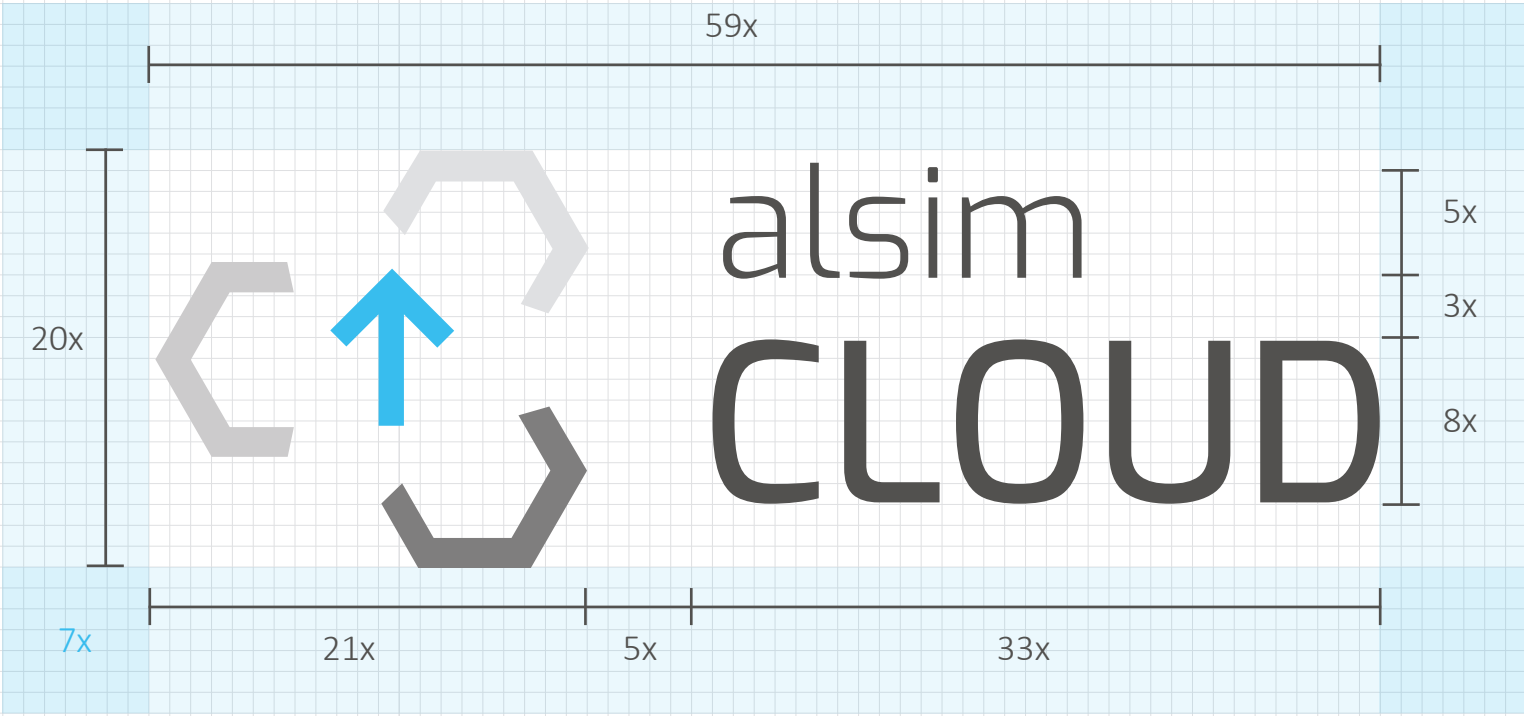

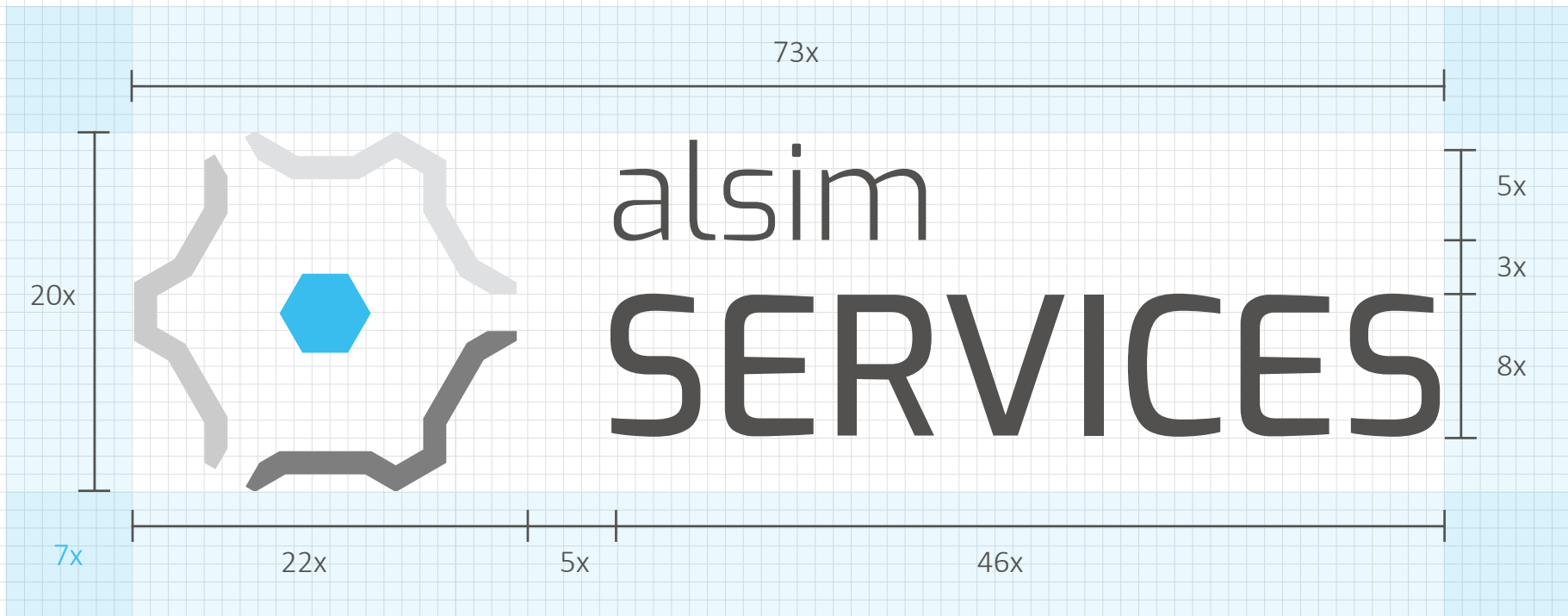

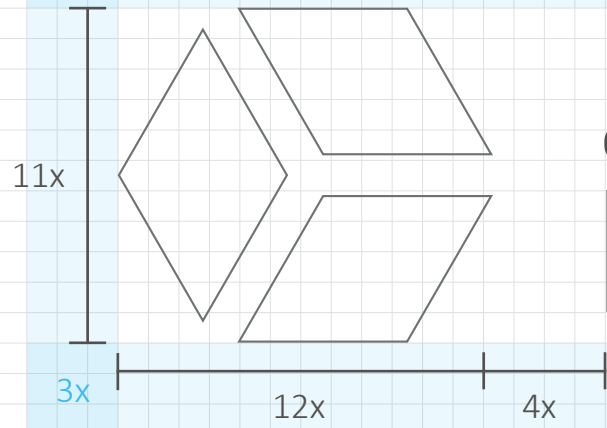

alsim

Product Name

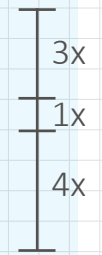



Positive



Negative



Tempered



Positive



Negative



Tempered



Positive



Negative



Tempered



Positive



Negative



Tempered



Positive



Negative



Tempered



Positive



Negative



Tempered



Positive



Negative



Tempered

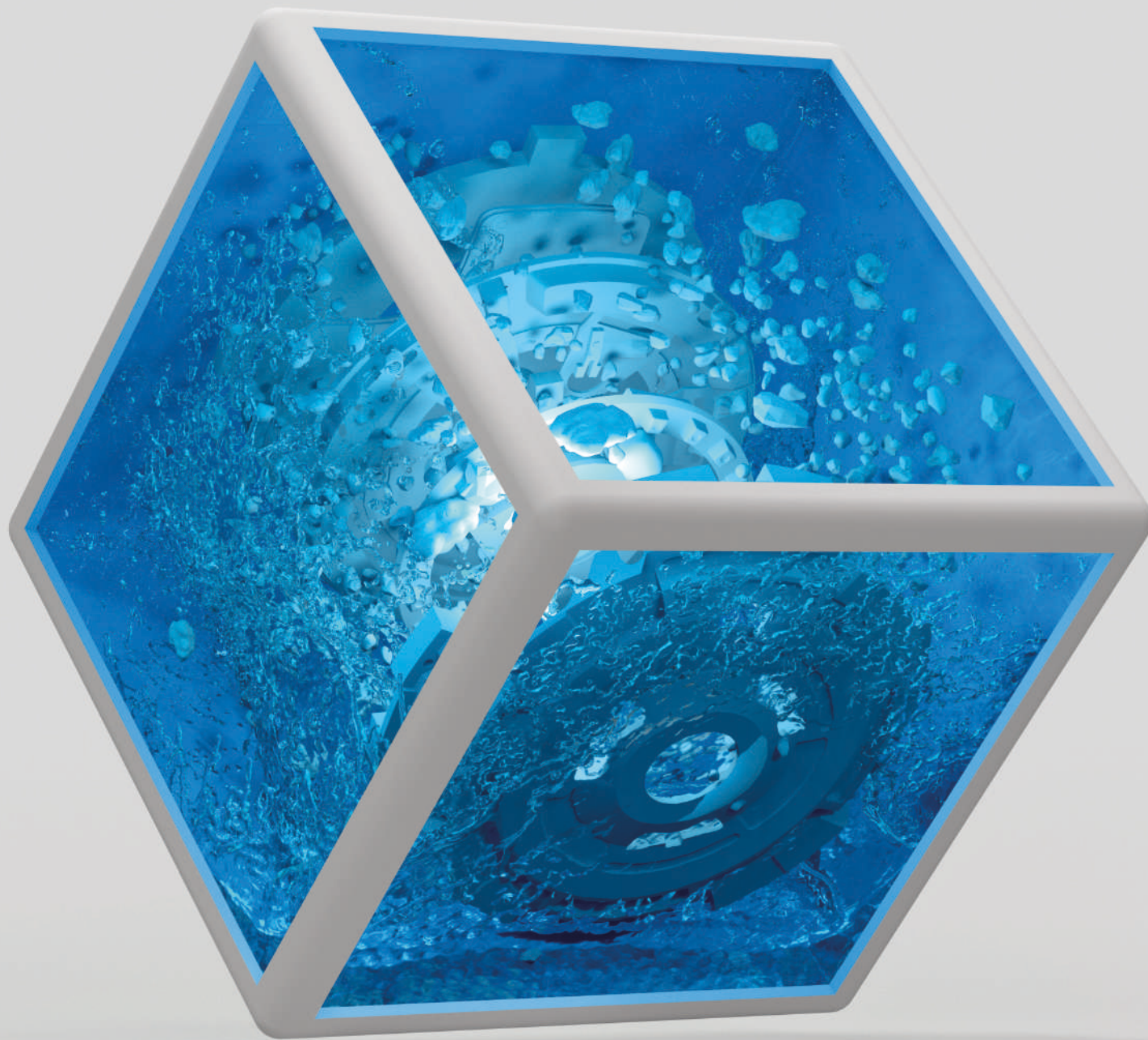

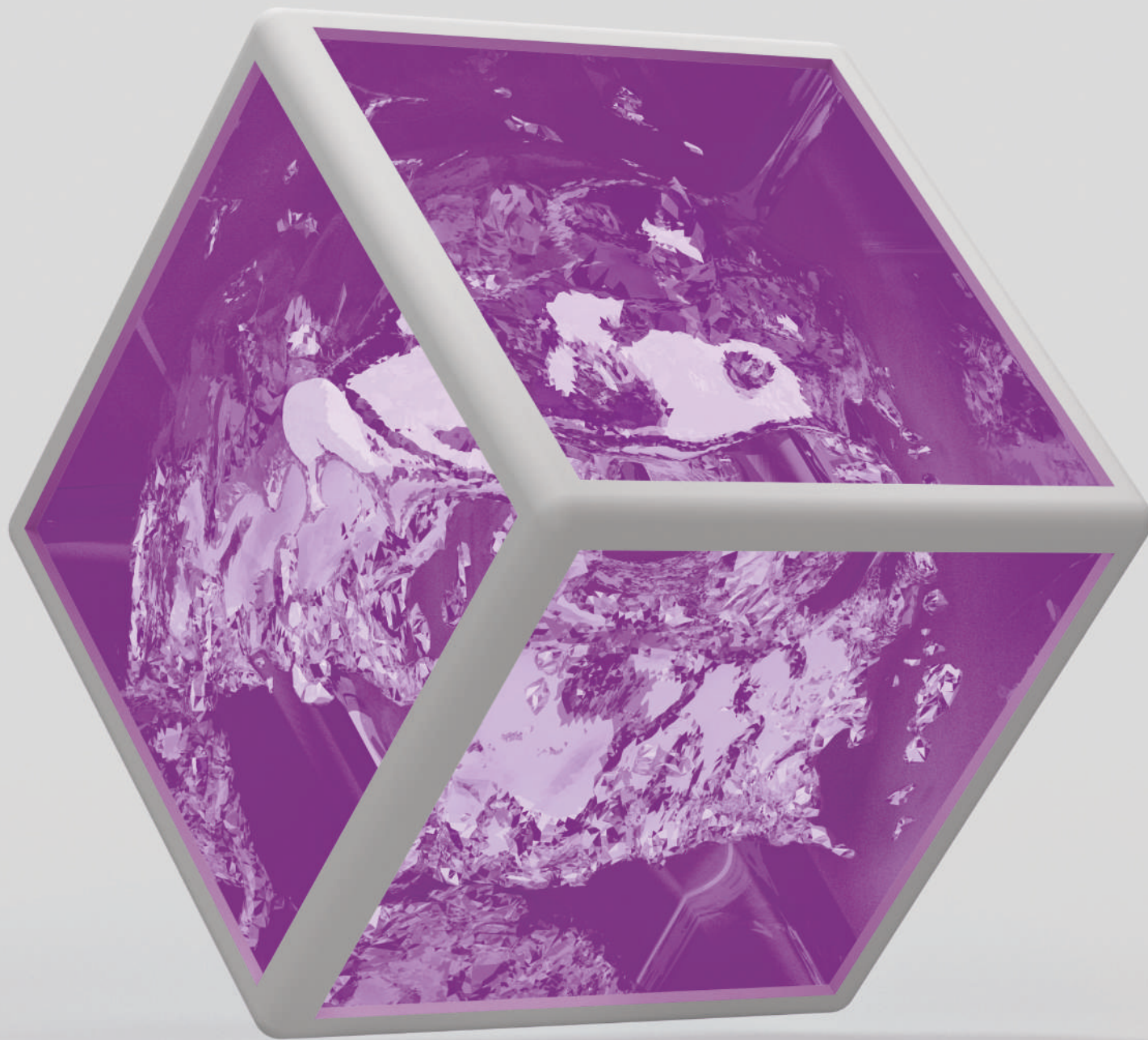

alsim
Paint Shop

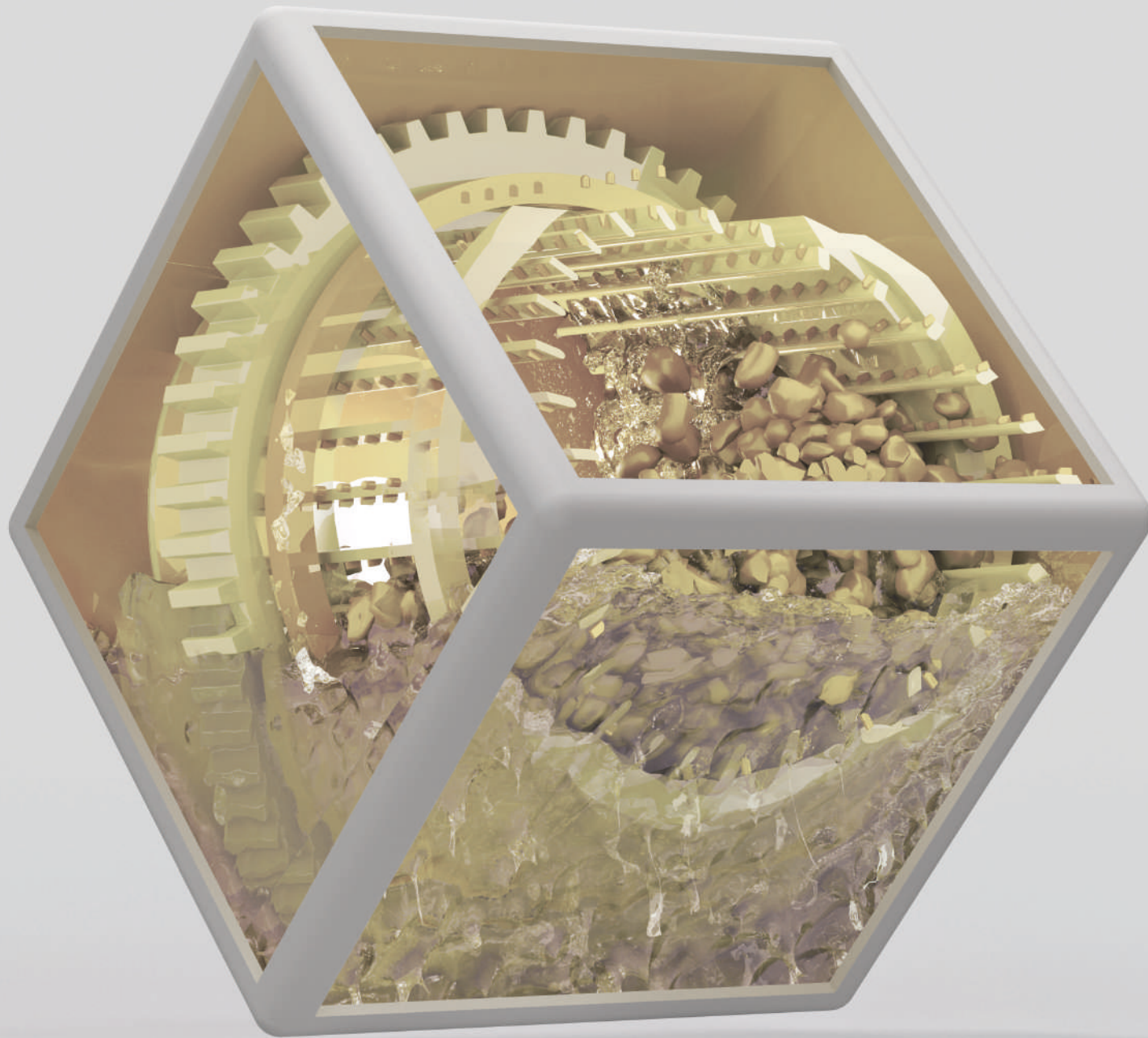

 alsim
Processing

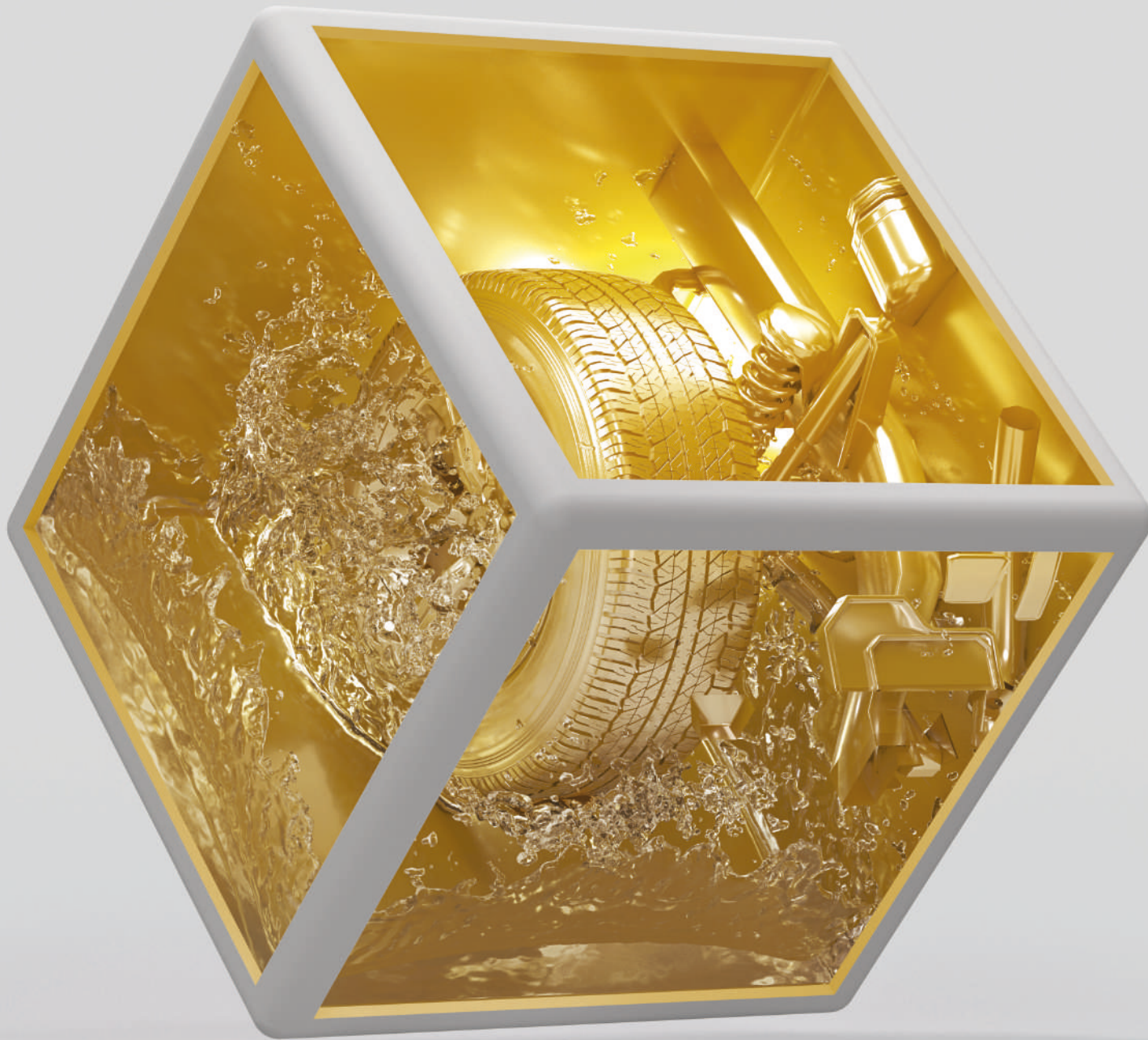

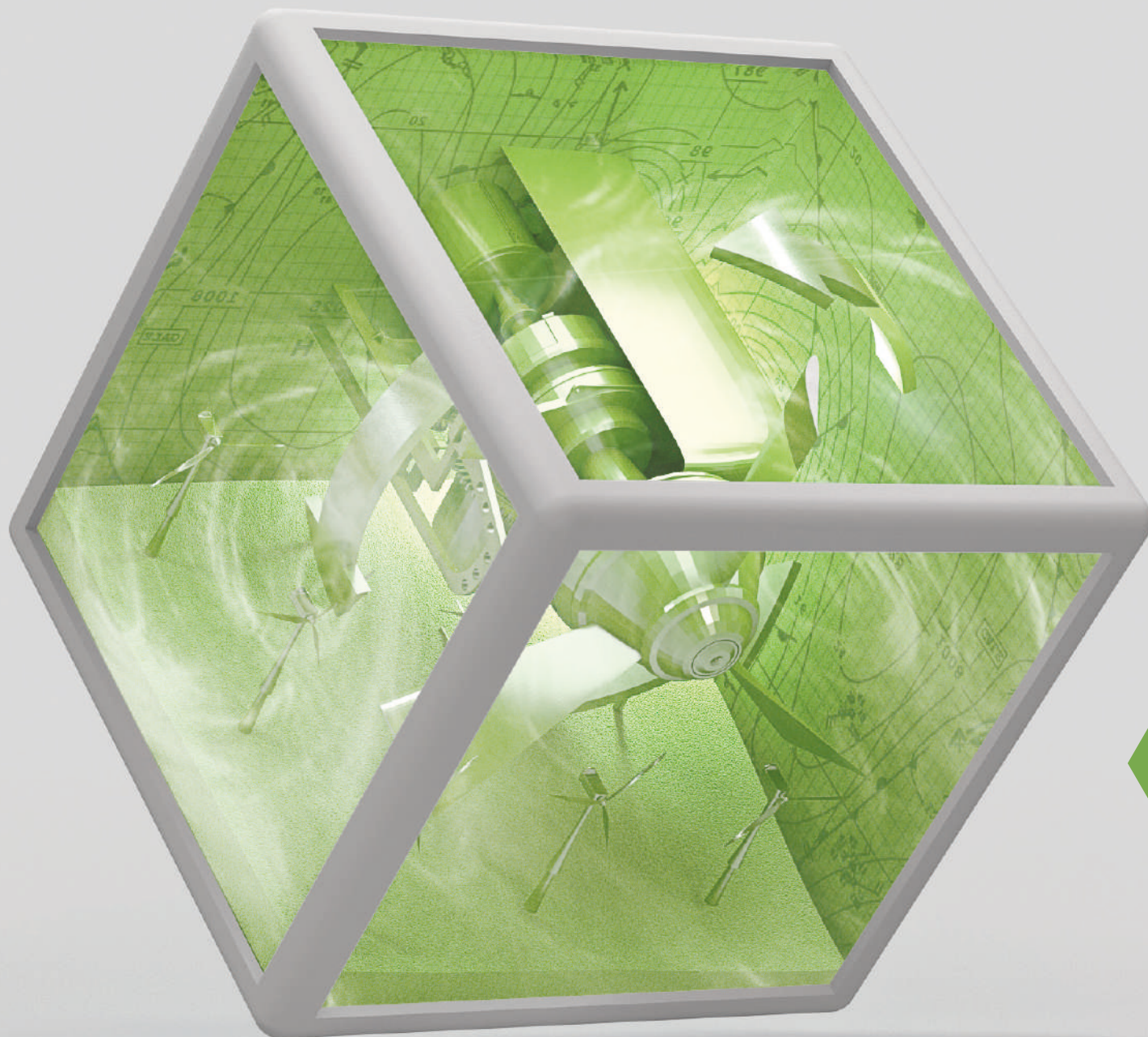

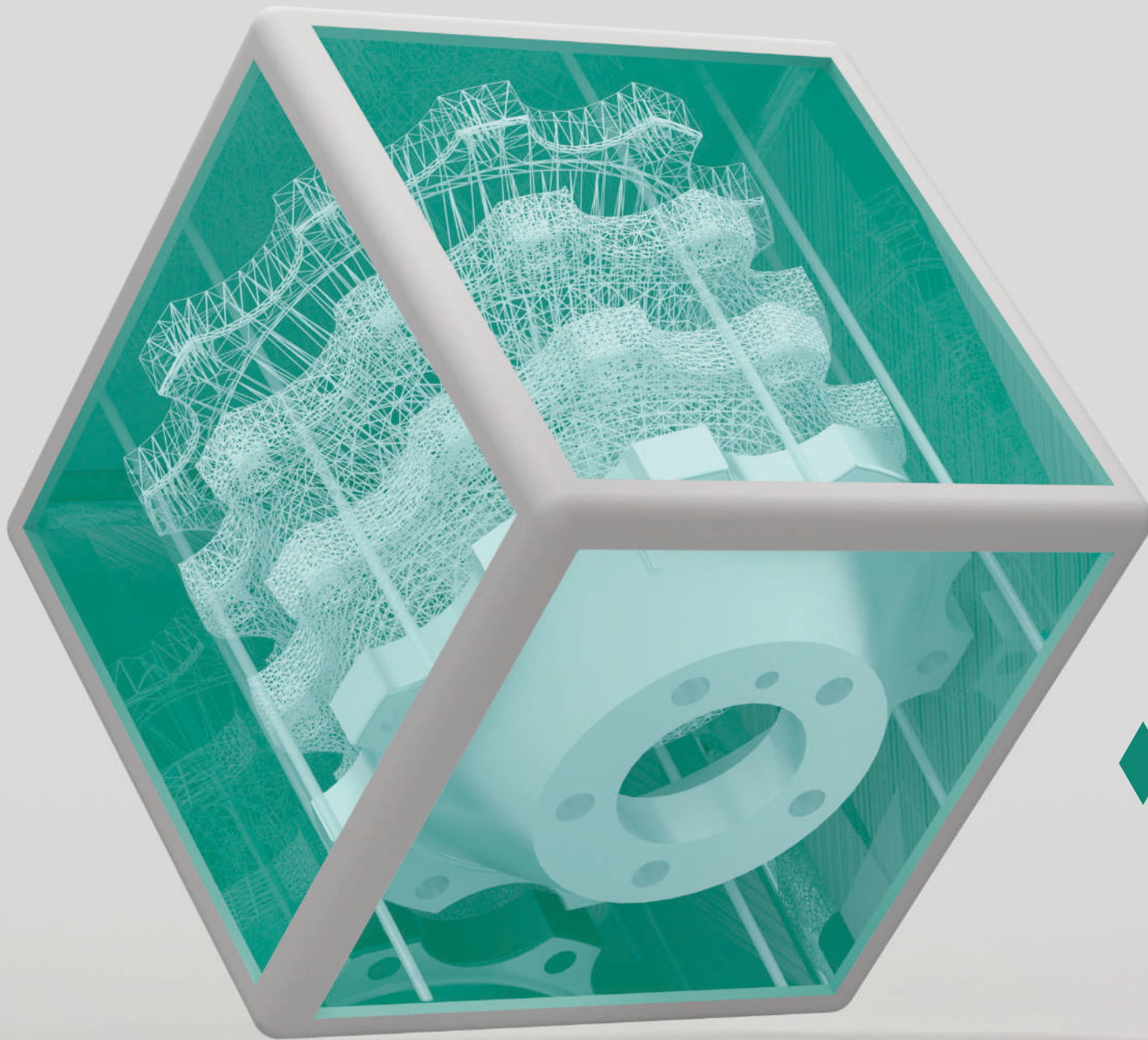

alsim
Data Cleaning

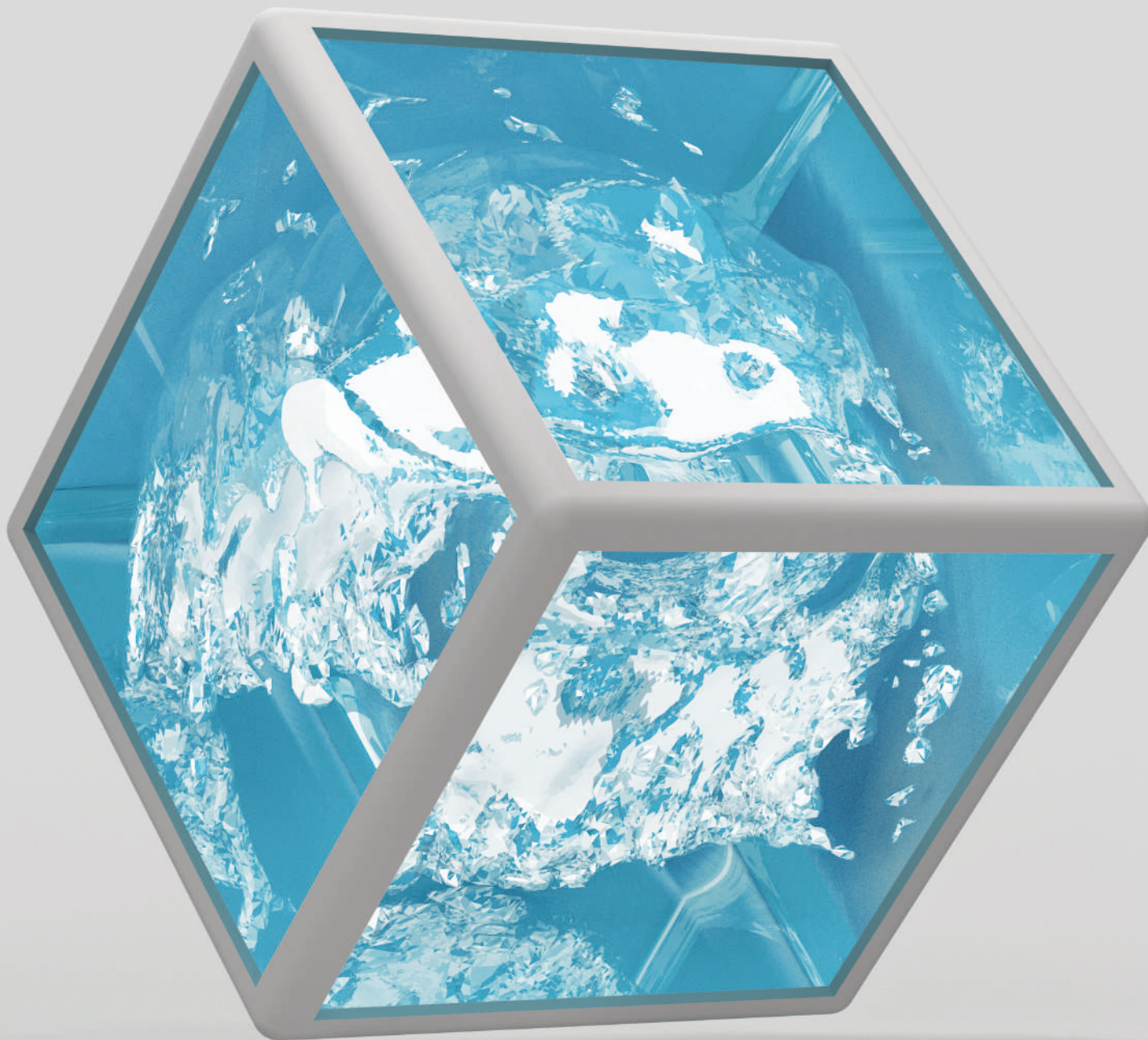

alsim
Washing

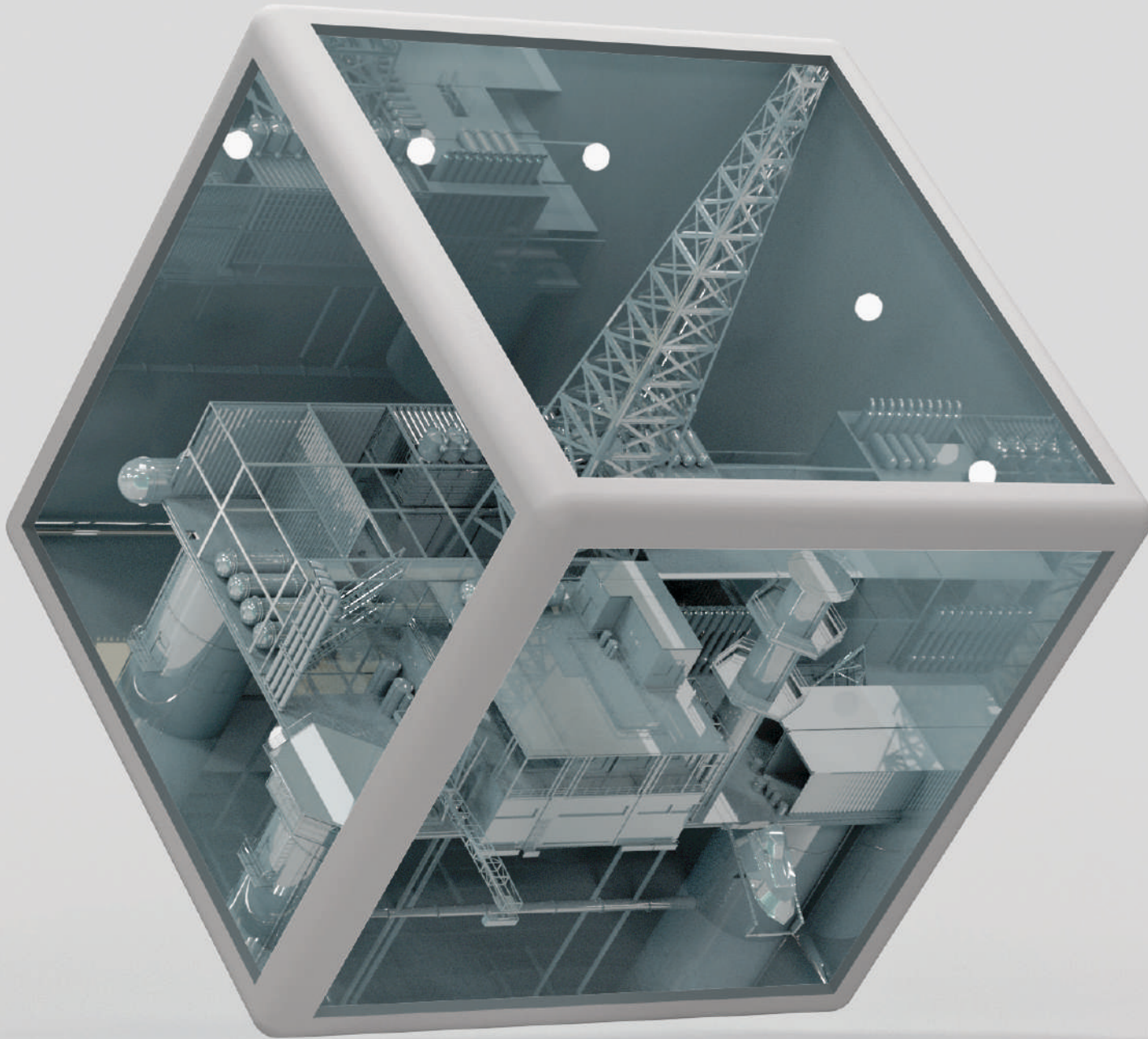

alsim
Oil & Gas